

RACCORDI DI LUCE JOY

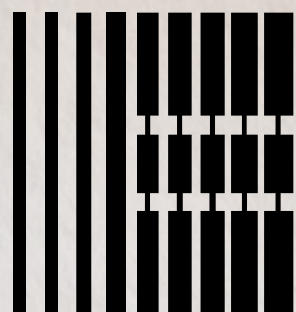



archiproducts® AWARDS WINNER

Siamo lieti di annunciare che Raccordi di Luce Joy ha vinto il premio Archiproducts Awards 2023 nella sezione Lighting Innovation.

We are thrilled to share that the Raccordi di Luce Joy has won the Archiproducts Awards 2023 section Lighting Innovation.

RACCORDI DI LUCE SYSTEM JOY SYSTEM

design: **officinadiarchitettura&design**

Sistema di luce modulare IP65 a luce diretta e apertura ottica di 73° con struttura in acciaio INOX 304 e alluminio con anodizzazione rinforzata per esterni oppure, nella finitura in acciaio satinato, in INOX AISI 316L.

FINITURE DISPONIBILI:

- .01 bianco
- .02 nero
- .06 verde
- .33 acciaio INOX AISI 316L
- .34 verniciato corten

RACCORDI DI LUCE SYSTEM – JOY SYSTEM rappresenta un modo nuovo e diverso d'interpretare la luce: partendo da un unico punto di alimentazione, la modularità dei vari elementi permette la realizzazione di infinite configurazioni portando la luce dove si vuole.

L'installazione può essere fatta sia in esterno sia in ambienti interni; a pavimento, a parete o a plafone.

Il suo funzionamento richiede l'utilizzo di un alimentatore da collocare in remoto e da ordinare separatamente.

IP65 modular light system with direct light and 73° optical aperture with structure in 304 stainless steel and aluminum with reinforced anodizing for outdoor use or, in the satin steel finish, in AISI 316L stainless steel.

AVAILABLE FINISHES:

- .01 white
- .02 black
- .06 green
- .33 AISI 316L stainless steel
- .34 painted corten

RACCORDI DI LUCE SYSTEM – JOY SYSTEM represents a new and different way of interpreting light: starting from a single power supply point, the modularity of the various elements allows for the creation of infinite configurations, bringing the light wherever you want.

The installation can be done both outdoors and indoors; on the floor, on the wall or on the ceiling.

Its operation requires the use of a driver to be positioned remotely and to be ordered separately.

Système d'éclairage modulaire IP65 à lumière directe et ouverture optique de 73° avec structure en acier inoxydable 304 et aluminium avec anodisation renforcée pour l'extérieur ou, dans la finition acier satiné, en acier inoxydable AISI 316L.

FINITIONS DISPONIBLES:

- .01 blanc
- .02 noir
- .06 vert
- .33 acier inoxydable AISI 316L
- .34 corten peint

RACCORDI DI LUCE SYSTEM – JOY SYSTEM représente une manière nouvelle et différente d'interpréter la lumière : à partir d'un seul point d'alimentation, la modularité des différents éléments permet de créer des configurations infinies, apportant la lumière où vous le souhaitez.

L'installation peut se faire aussi bien à l'extérieur qu'à l'intérieur; au sol, au mur ou au plafond.

Son fonctionnement nécessite l'utilisation d'une alimentation à positionner à distance et à commander séparément.

Sistema de iluminación modular IP65 de luz directa y apertura óptica de 73° con estructura en acero inoxidable 304 y aluminio con anodizado reforzado para uso exterior o, en el acabado acero satinado, en acero inoxidable AISI 316L.

ACABADOS DISPONIBLES:

- .01 blanco
- .02 negro
- .06 verde
- .33 acero inoxidable AISI 316L
- .34 corten pintado

RACCORDI DI LUCE SYSTEM – JOY SYSTEM representa una forma nueva y diferente de interpretar la luz: partiendo de un único punto de alimentación, la modularidad de los distintos elementos permite crear infinitas configuraciones, llevando la luz donde tú quieras.

La instalación se puede realizar tanto en exterior como en interior; en el suelo, en la pared o en el techo.

Su funcionamiento requiere el uso de una fuente de alimentación que se colocará de forma remota y se pedirá por separado.

Modulares IP65-Lichtsystem mit direktem Licht und 73° optischer Öffnung mit Struktur aus Edelstahl 304 und Aluminium mit verstärkter Eloxierung für den Außenbereich oder in der Ausführung Edelstahl AISI 316L.

VERFÜGBARE AUSFÜHRUNGEN:

- .01 weiß
- .02 schwarz
- .06 grün
- .33 edelstahl AISI 316L
- .34 lackierter corten

RACCORDI DI LUCE SYSTEM – JOY SYSTEM stellt eine neue und andere Art dar, Licht zu interpretieren: Ausgehend von einem einzigen Stromanschlusspunkt ermöglicht die Modularität der verschiedenen Elemente die Schaffung unendlicher Konfigurationen, um das Licht dorthin zu bringen, wo Sie es wünschen.

Die Installation kann sowohl im Freien als auch im Innenbereich erfolgen; auf dem Boden, an der Wand oder an der Decke.

Sein Betrieb erfordert die Verwendung eines Netzteils, das entfernt positioniert und separat bestellt werden muss.

Модульная световая система IP65 с прямым светом и оптической апертурой 73° со структурой из нержавеющей стали 304 и алюминия с усиленным анодированием для наружного использования или с отделкой из satinированной стали из нержавеющей стали AISI 316L.

ДОСТУПНЫЕ ОТДЕЛКИ:

- .01 белый
- .02 черный
- .06 зеленый
- .33 Нержавеющая сталь AISI 316L
- .34 окрашенный кортен

RACCORDI DI LUCE SYSTEM – JOY SYSTEM представляет собой новый и необычный способ интерпретации света: начиная с одной точки питания, модульность различных элементов позволяет создавать бесконечные конфигурации, направляя свет туда, куда вы хотите.

Монтаж можно производить как снаружи, так и внутри помещения; на полу, на стене или на потолке.

Его работа требует использования источника питания, который должен быть расположен удаленно и заказывается отдельно.



Illuminatori

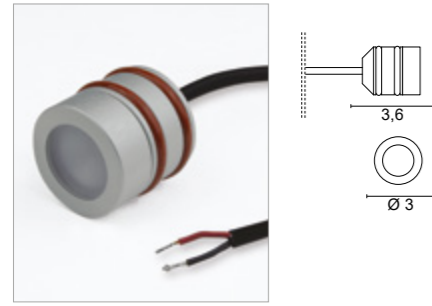

7516

3cm

.45 Alluminio anodizzato - Aluminium anodized

Color temperature	LED Light sources	lm source
/W 4000K	1,5W 500mA	221lm
/WW 3000K	1,5W 500mA	210lm
/XW 2700K	1,5W 500mA	199lm

IP65 100 cm 75° 0,08 Kg

Drivers ON/OFF

Cod. LED	0143/IP	0127
	500mA	500mA
7516	1-7	1-6

Solo collegamento in serie - Only serial connection

Elementi - elements

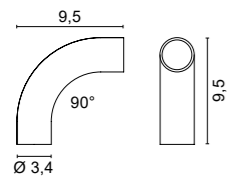
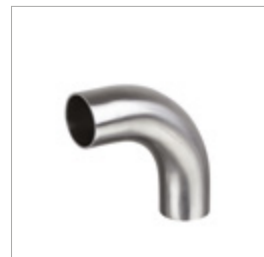

7500

Curva a mandrinare 90°
90° expanding bend

- .01 Bianco - White
- .02 Nero - Black
- .06 Verde - Green
- .33 Acciaio - Stell
- Inox AISI 316L
- .34 Verniciato corten
Painted corten finishing

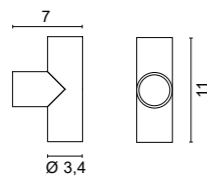

7501

Giunto a T a mandrinare
T joint expanding bend

- .01 Bianco - White
- .02 Nero - Black
- .06 Verde - Green
- .33 Acciaio - Stell
- Inox AISI 316L
- .34 Verniciato corten
Painted corten finishing

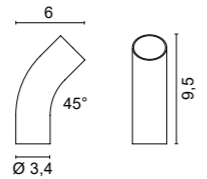
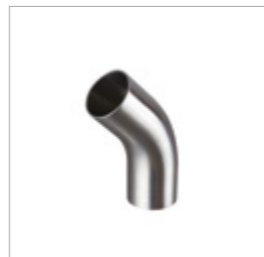

7504

Curva a mandrinare 45°
45° expanding bend

- .01 Bianco - White
- .02 Nero - Black
- .06 Verde - Green
- .33 Acciaio - Stell
- Inox AISI 316L
- .34 Verniciato corten
Painted corten finishing

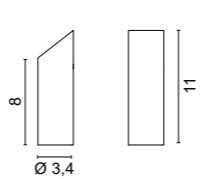

7505

Giunto con taglio a 45°
Joint with 45° cut

- .01 Bianco - White
- .02 Nero - Black
- .06 Verde - Green
- .33 Acciaio - Stell
- Inox AISI 316L
- .34 Verniciato corten
Painted corten finishing

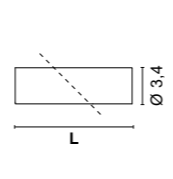

7508

Tubo lineare
Linear tube

- .01 Bianco - White
- .02 Nero - Black
- .06 Verde - Green
- .33 Acciaio - Stell
- Inox AISI 316L
- .34 Verniciato corten
Painted corten finishing

Lunghezza L - Length L

/10	10cm
/20	20cm
/50	50cm
/100	100cm
/150	150cm



.01 Bianco - White .02 Nero - Black .06 Verde - Green .33 Acciaio - Stell Inox AISI 316L .34 Verniciato corten Painted corten finishing

Congiunzioni

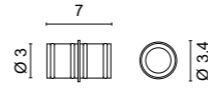

7510

Elemento di giunzione
Junction element

- .02 Nero - Black

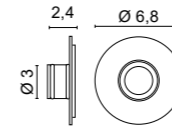

7521

Base a muro in alluminio con copribase
Wall base in aluminum with cover disc

- .01 Bianco - White
- .02 Nero - Black
- .06 Verde - Green
- .33 Acciaio - Stell
- Inox AISI 316L
- .34 Verniciato corten
Painted corten finishing

Optional

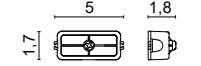

0276

Connettore IP67
IP67 connector

Casseforme / Basi

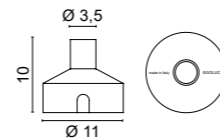

0228/R

Cassforma drenante
Draining junction box

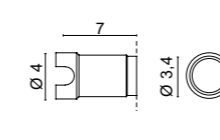

0216

Plastic box

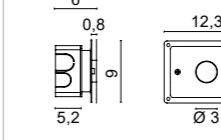

0213

Box + plaster

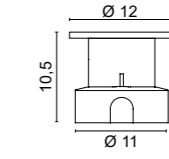

0246/R

Box + plate con viti d'acciaio
Box + plate with steel screws

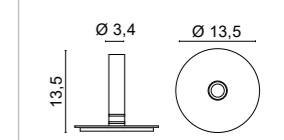

7522

Base con disco copribase
Base with cover disc

- .01 Bianco - White
- .02 Nero - Black
- .06 Verde - Green
- .33 Acciaio - Stell
- Inox AISI 316L
- .34 Verniciato corten
Painted corten finishing

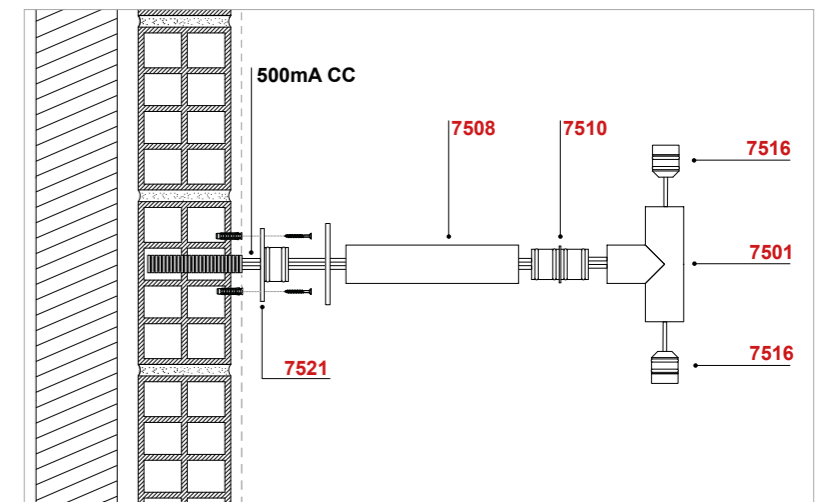

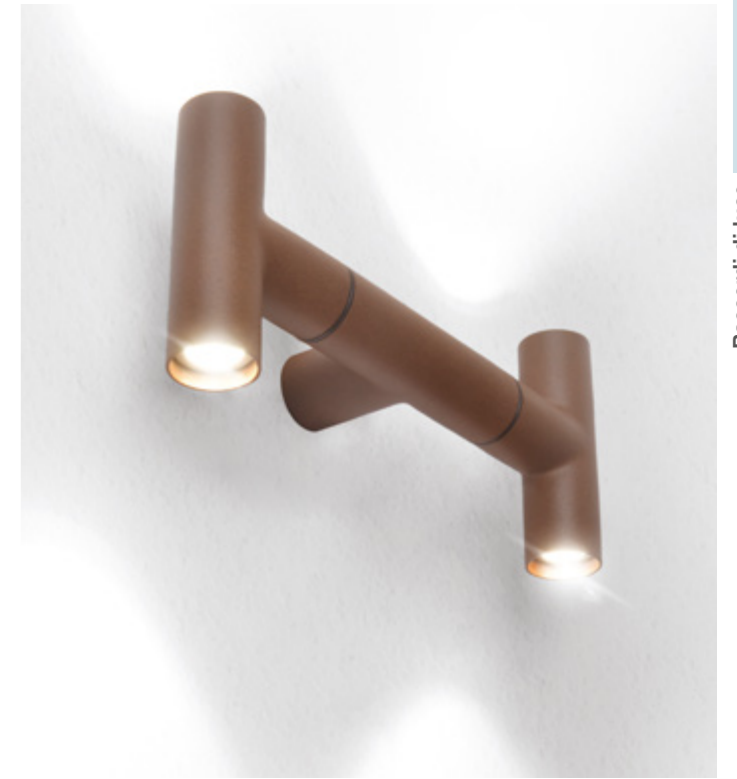
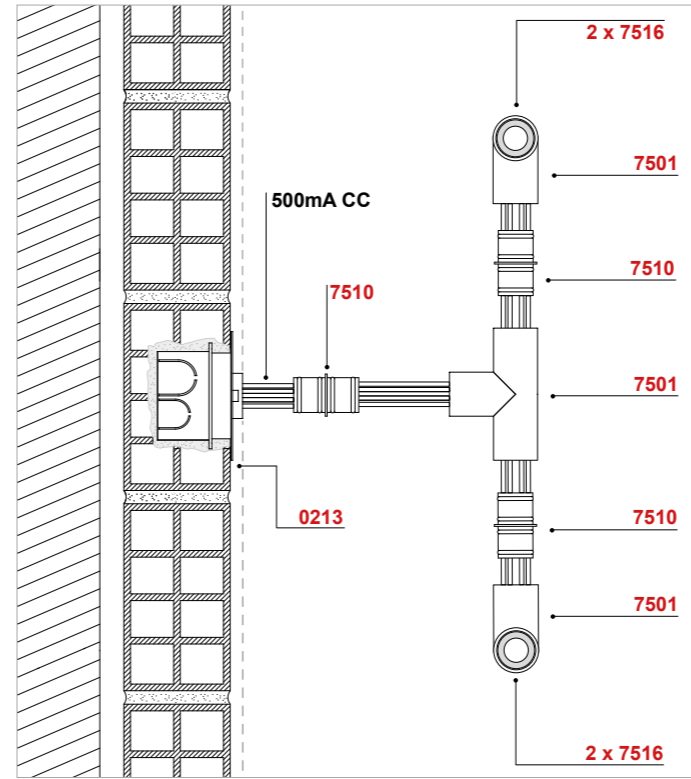

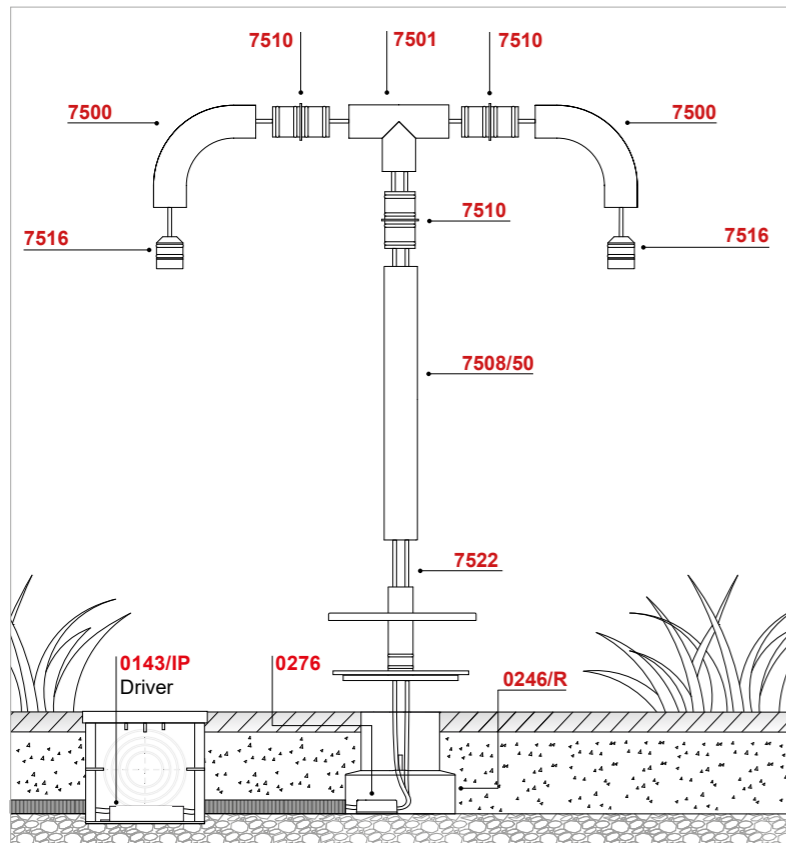

I drivers, da ordinare separatamente, devono essere collocati in remoto
 The drivers, to be ordered separately, must be placed remotely

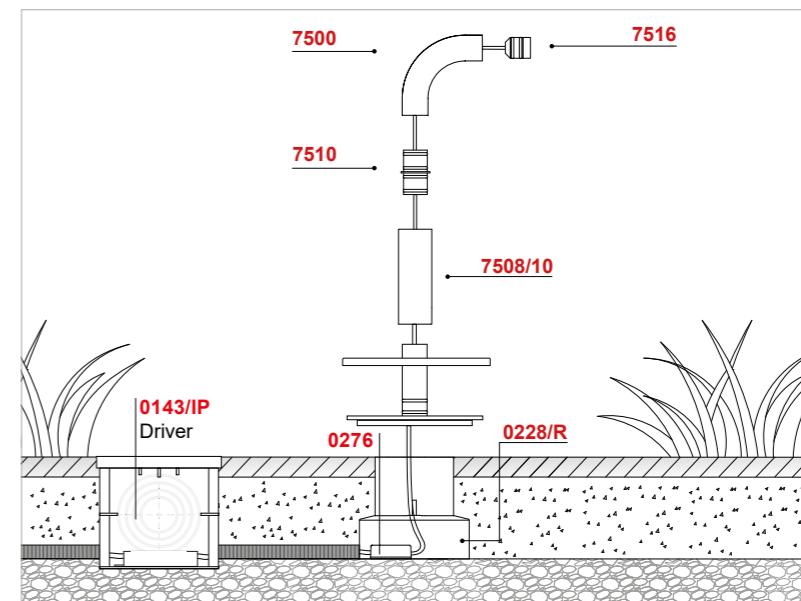
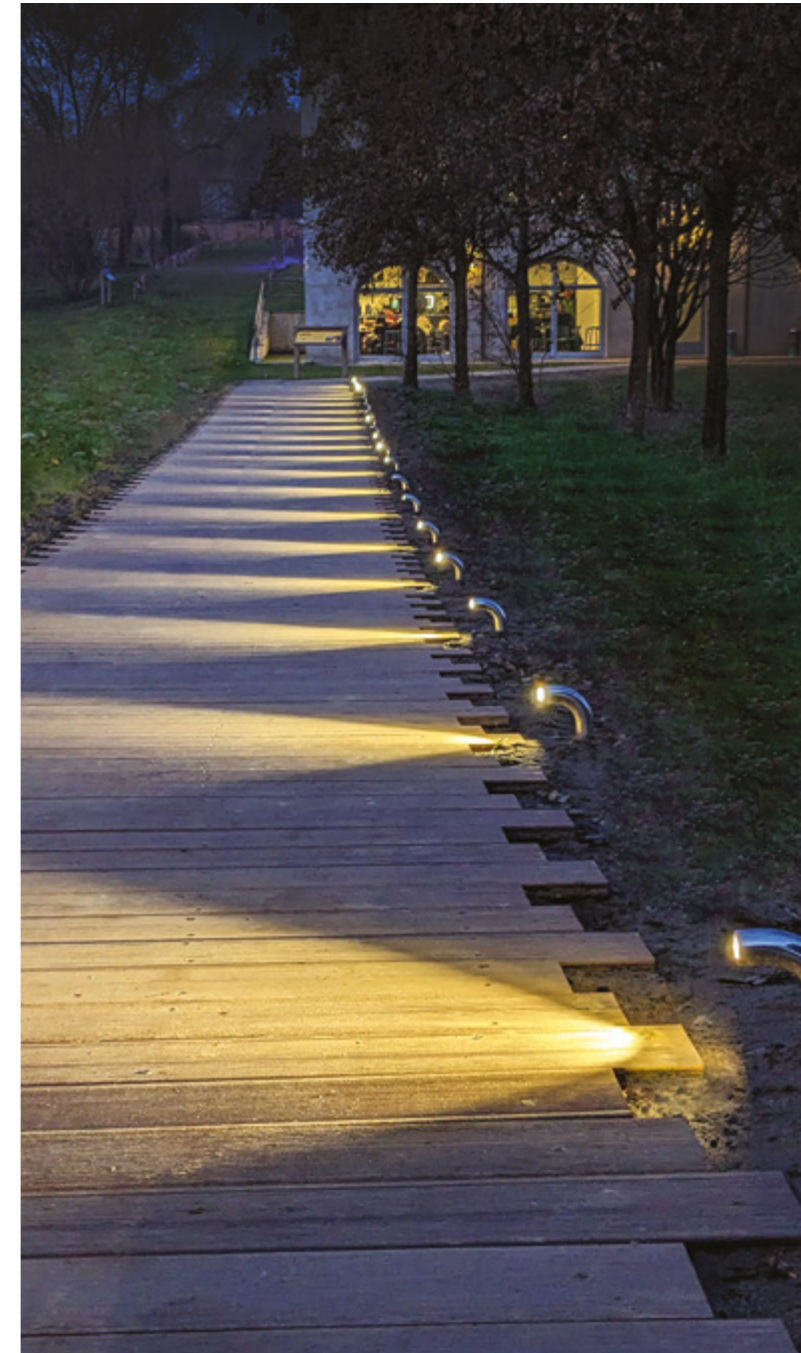

Raccordi di luce



Raccordi di luce





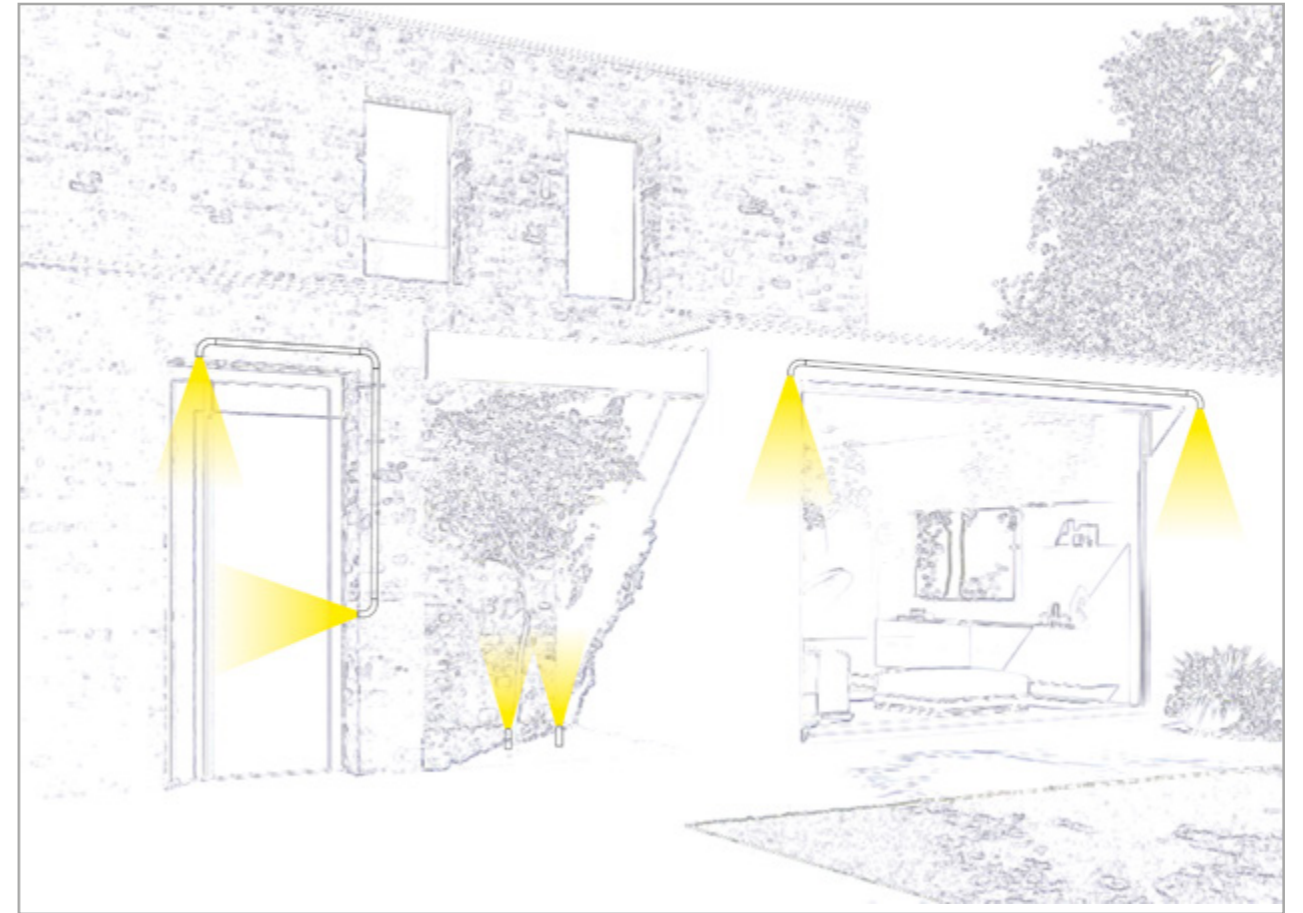
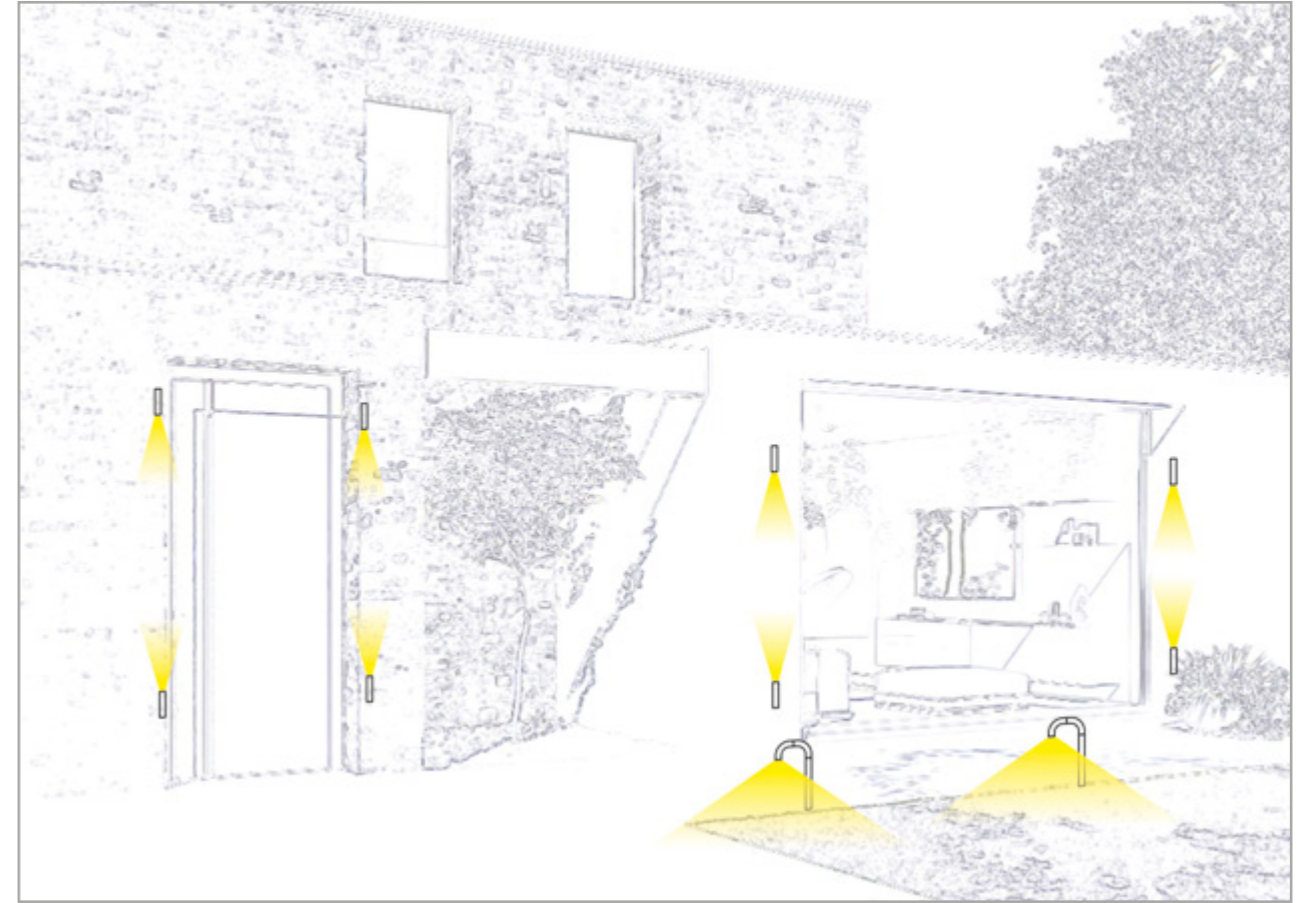
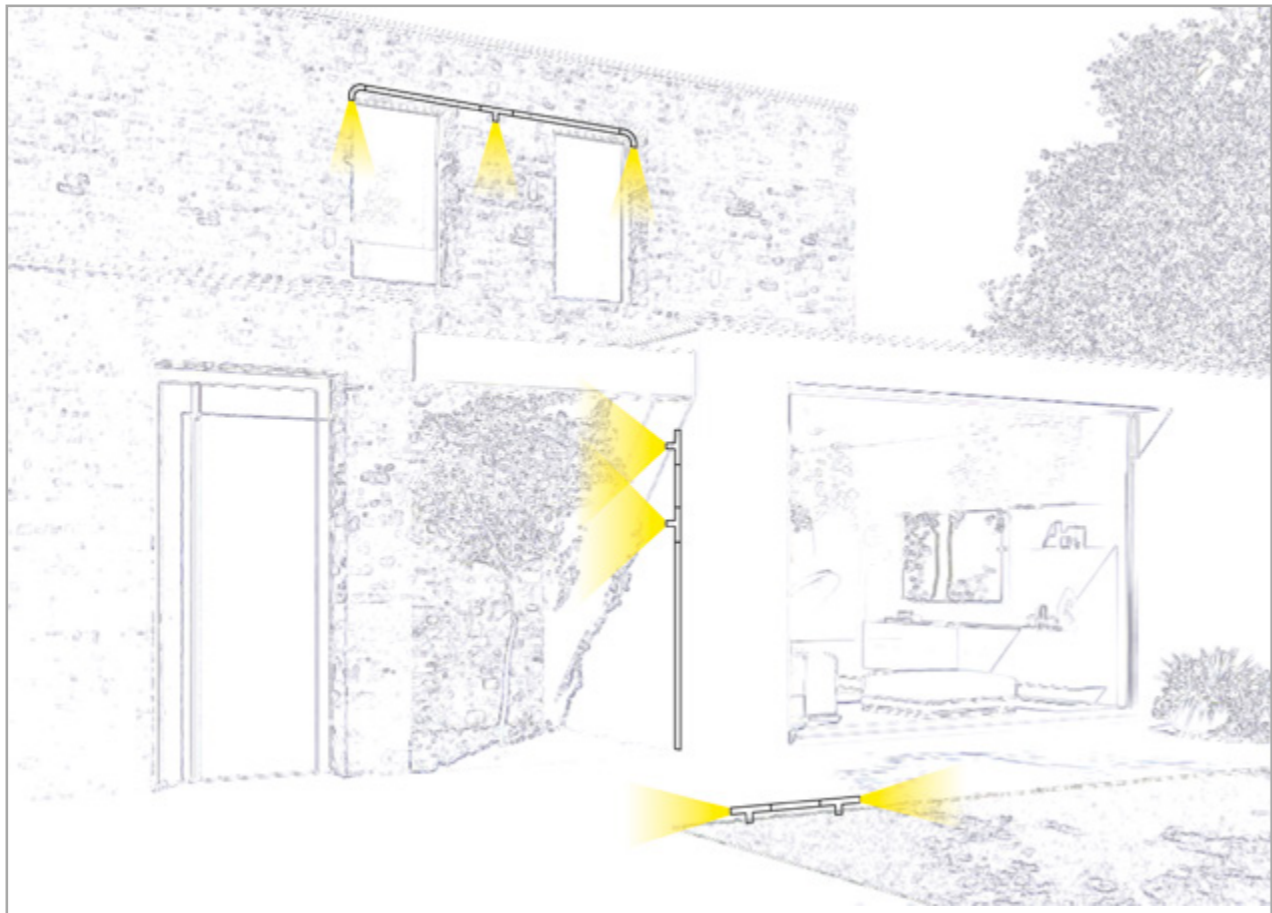
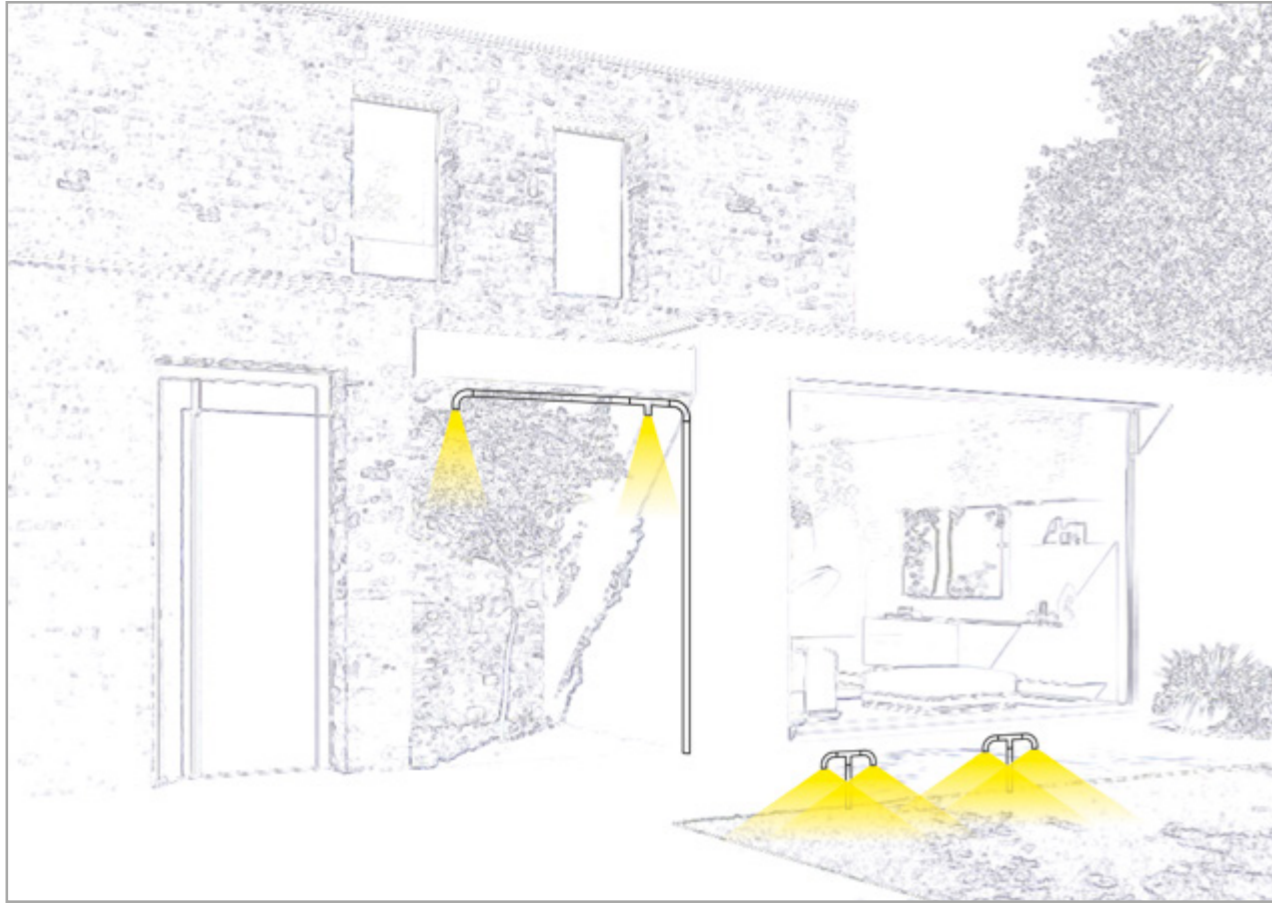



RACCORDI DI LUCE JOY

design: **officinadiarchitettura&design**

Collezione di lampade IP65 a luce diretta da parete, plafone e terra, sia per esterno sia per interno, con struttura in acciaio INOX 304 e alluminio con anodizzazione rinforzata per esterni oppure, nella finitura in acciaio satinato, in INOX AISI 316L.

FINITURE DISPONIBILI:

- .01 bianco
- .02 nero
- .33 acciaio INOX AISI 316L
- .34 verniciato corten

Le ridotte dimensioni e il tipo di luce, grazie all'apertura ottica di 73°, sono ideali per illuminare passaggi o particolari ambienti esterni, giardini o per creare giochi di luce su facciate di case o illuminare percorsi sotto piccoli portici o verande.

Il suo funzionamento richiede l'utilizzo di un alimentatore da collocare in remoto e da ordinare separatamente.

Collection of IP65 direct light wall, ceiling and floor lamps, for both outdoor and indoor use, with structure in 304 stainless steel and aluminum with reinforced anodizing for outdoor use or, in the satin steel finish, in AISI 316L stainless steel.

AVAILABLE FINISHES:

- .01 white
- .02 black
- .33 AISI 316L stainless steel
- .34 painted corten

The small size and the type of light, thanks to beam optic of 73°, are ideal for illuminating passageways or particular outdoor environments, gardens or for creating plays of light on house facades or illuminating paths under small porches or verandas.

Its operation requires the use of a driver to be placed remotely and to be ordered separately.

Collection d'appliques, plafonniers et lampadaires à lumière directe IP65, pour l'extérieur et l'intérieur, avec structure en acier inoxydable 304 et aluminium avec anodisation renforcée pour l'extérieur ou, dans la finition acier satiné, en acier inoxydable AISI 316L.

FINITIONS DISPONIBLES:

- .01 blanc
- .02 noir
- .33 acier inoxydable AISI 316L
- .34 corten peint

La petite taille et le type de lumière, grâce à l'ouverture optique de 73°, sont idéaux pour éclairer des passages ou des environnements extérieurs particuliers, des jardins ou pour créer des jeux de lumière sur les façades de maisons ou éclairer des allées sous de petits porches ou vérandas.

Son fonctionnement nécessite l'utilisation d'une alimentation à placer à distance et à commander séparément.

archiproducts® AWARDS WINNER

Siamo lieti di annunciare che Raccordi di Luce Joy ha vinto il premio Archiproducts Awards 2023 nella sezione Lighting Innovation.

We are thrilled to share that the Raccordi di Luce Joy has won the Archiproducts Awards 2023 section Lighting Innovation.

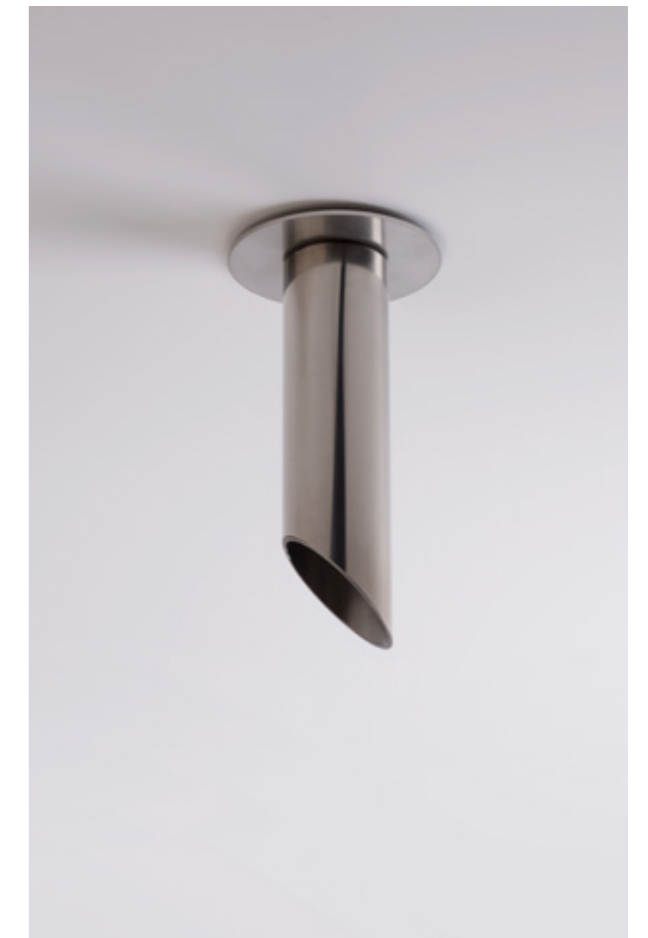

Colección de apliques, plafones y lámparas de pie de luz directa IP65, tanto para uso exterior como interior, con estructura en acero inoxidable 304 y aluminio con anodizado reforzado para uso exterior o, en el acabado acero satinado, en acero inoxidable AISI 316L.

ACABADOS DISPONIBLES:

- .01 blanco
- .02 negro
- .33 acero inoxidable AISI 316L
- .34 corten pintado

El pequeño tamaño y el tipo de luz, gracias a la apertura óptica de 73°, son ideales para iluminar zonas de paso o ambientes exteriores particulares, jardines o para crear juegos de luz en fachadas de casas o iluminar caminos bajo pequeños porches o terrazas.

Su funcionamiento requiere el uso de una fuente de alimentación que se colocará de forma remota y se pedirá por separado.

Kollektion von Wand-, Decken- und Stehleuchten mit IP65-Direktlicht für den Außen- und Innenbereich, mit Struktur aus Edelstahl 304 und Aluminium mit verstärkter Eloxierung für den Außenbereich oder in satinierter Stahlausführung aus Edelstahl AISI 316L.

VERFÜGBARE AUSFÜHRUNGEN:

- .01 weiß
- .02 schwarz
- .33 edelstahl AISI 316L
- .34 lackierter corten

Die geringe Größe und die Art des Lichts, dank der optischen Öffnung von 73°, sind ideal für die Beleuchtung von Durchgängen oder bestimmten Außenumgebungen, Gärten oder zur Schaffung von Lichtspielen an Hausfassaden oder zur Beleuchtung von Wegen unter kleinen Veranden oder Veranden.

Sein Betrieb erfordert die Verwendung eines Netzteils, das entfernt positioniert und separat bestellt werden muss.

Collezione di lampade a luce diretta da parete, plafone e terra, sia per esterno sia per interno, con struttura in acciaio INOX 304 e alluminio con anodizzazione rinforzata per esterni oppure, nella finitura in acciaio satinato, in INOX AISI 316L.

ДОСТУПНЫЕ ОТДЕЛКИ:

- .01 белый
- .02 черный
- .33 Нержавеющая сталь AISI 316L
- .34 окрашенный кортен

Небольшой размер и тип света, благодаря оптической апертуре 73°, идеально подходят для освещения проходов или отдельных наружных пространств, садов или для создания световых игр на фасадах домов или для освещения дорожек под небольшими верандами или верандами.

Его работа требует использования источника питания, который должен быть расположен удаленно и заказывается отдельно.



Raccordi di luce

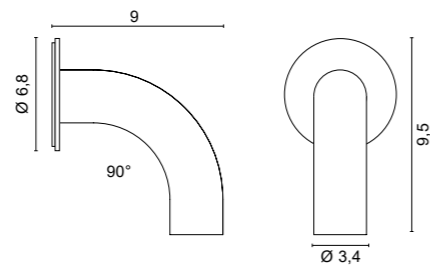
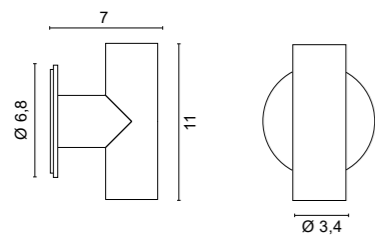
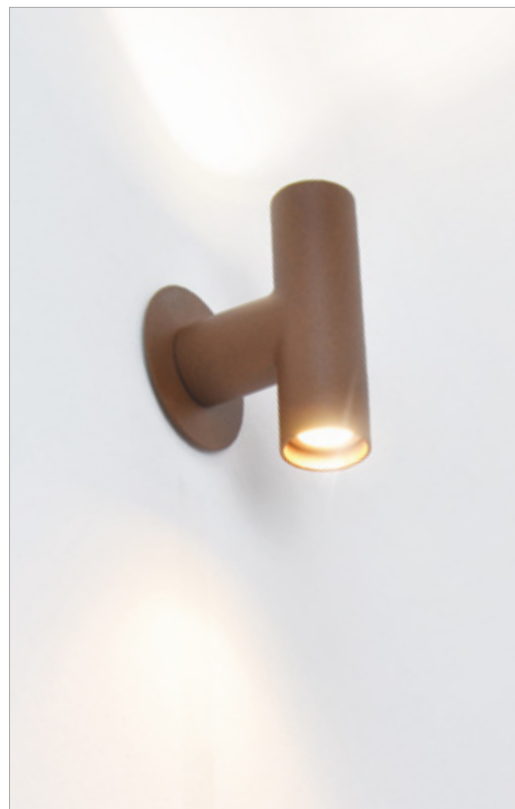

4672

- .01 Bianco - White
- .02 Nero - Black
- .33 Acciaio - Stell (Inox AISI 316L)
- .34 Verniciato corten - Painted corten

Color temperature	LED Light source	lm source
/W 4000K	3W 500mA	442lm
/WW 3000K	3W 500mA	420lm
/XW 2700K	3W 500mA	398lm

IP65 0,31 Kg

4673

- .01 Bianco - White
- .02 Nero - Black
- .33 Acciaio - Stell (Inox AISI 316L)
- .34 Verniciato corten - Painted corten

Color temperature	LED Light source	lm source
/W 4000K	1,5W 500mA	221lm
/WW 3000K	1,5W 500mA	210lm
/XW 2700K	1,5W 500mA	199lm

IP65 0,25 Kg



.01 Bianco - White .02 Nero - Black .33 Acciaio - Stell Inox AISI 316L .34 Verniciato corten Painted corten finishing



Raccordi di luce

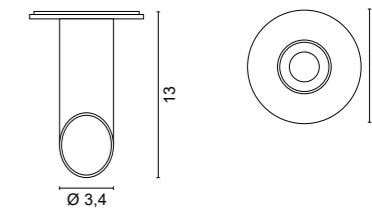

5690

- .01 Bianco - White
- .02 Nero - Black
- .33 Acciaio - Stell (Inox AISI 316L)
- .34 Verniciato corten - Painted corten

Color temperature	LED Light source	lm source
/W 4000K	1,5W 500mA	221lm
/WW 3000K	1,5W 500mA	210lm
/XW 2700K	1,5W 500mA	199lm

IP65 0,25 Kg

Drivers ON/OFF

Cod. LED	0143/IP 500mA	0127 500mA
4672	1-3	1-3
4673	1-7	1-6
5690	1-7	1-6

Solo collegamento in serie - Only serial connection

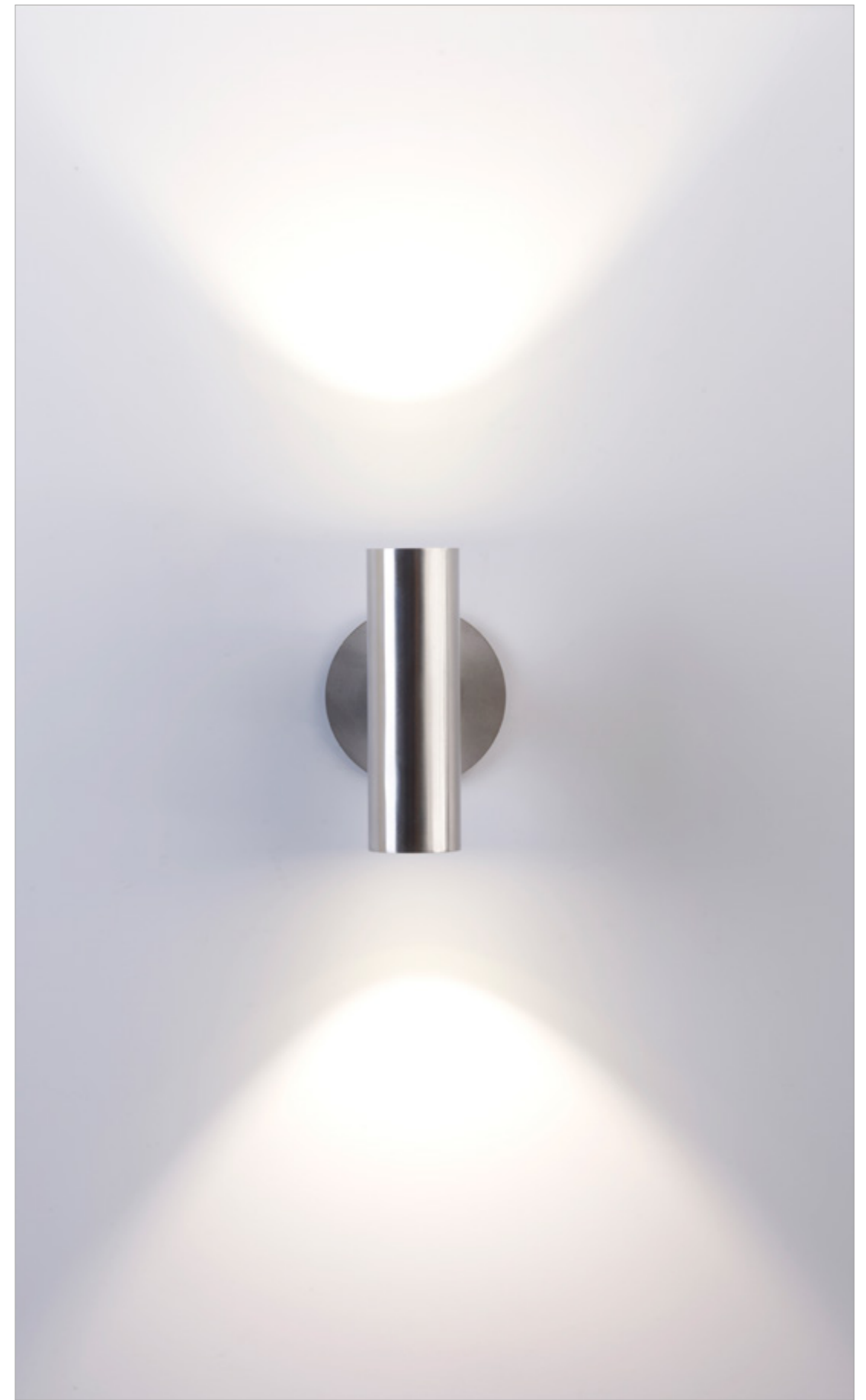



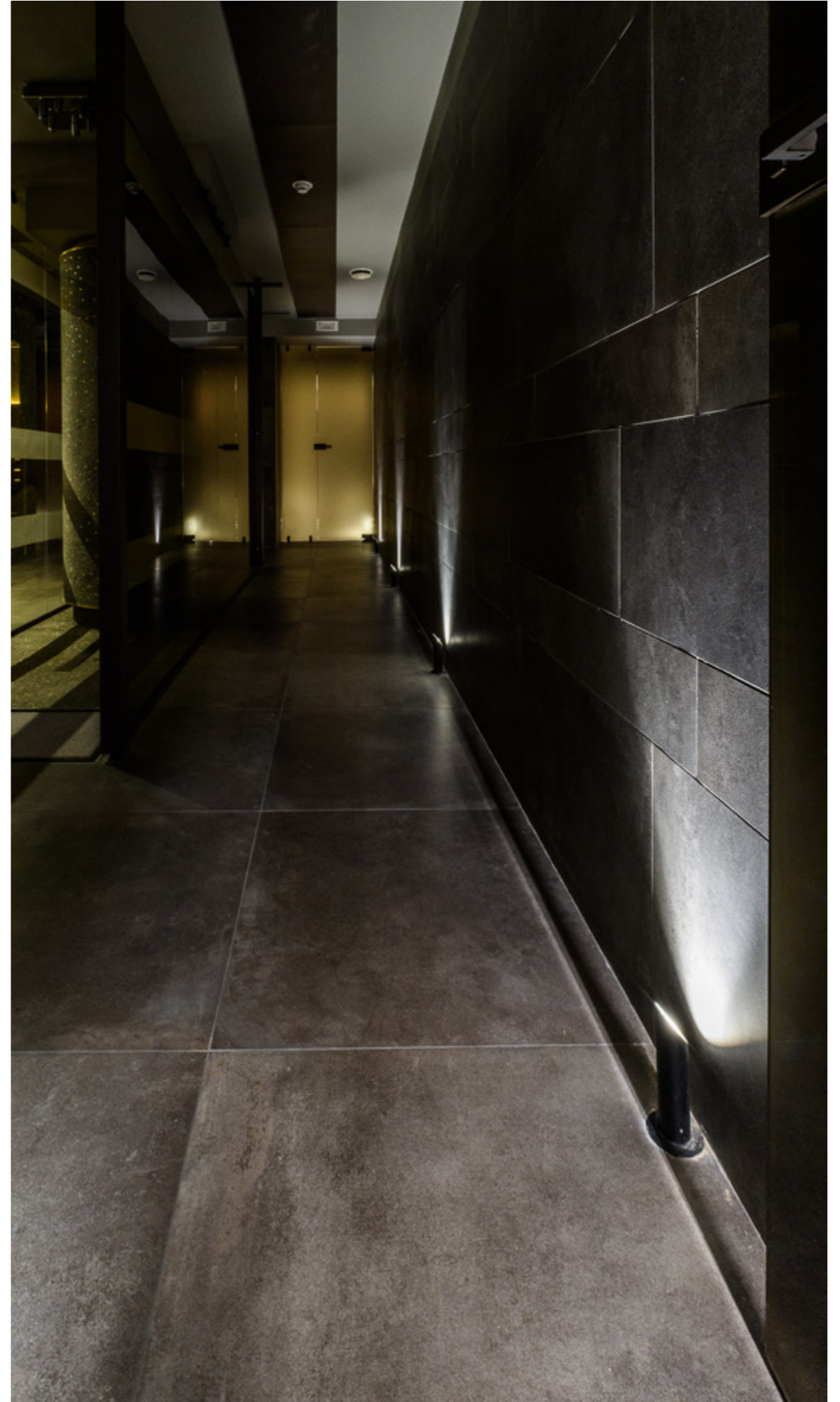



.01 Bianco - *White*



.33 Acciaio - *Stell*
Inox AISI 316L



.02 Nero - *Black*



.34 Verniciato corten
Painted corten finishing



.06 Verde - *Green*

I nostri prodotti sono costruiti in conformità alle norme europee CEI-EN 60598 e, come tali, recano la marcatura CE.

Our fittings are manufactured in conformity with the european standard CEI-EN 60598 and, consequently, get the mark CE.

Nos appareils sont fabriqués en conformité aux règles européennes CEI-EN 60598 et, par conséquence, fournis avec marque CE.

Unsere Produkte werden gemäss europäischer Norm CEI-EN 60598 hergestellt und sind als solche mit dem CE-Zeichen gekennzeichnet.

Nuestros productos son fabricados de conformidad con las normas europeas UNE EN 60598 y, como tal, lleva la marca CE.

Наши изделия изготовлены в соответствии с европейскими нормами CEI-EN 60598 и поэтому отмечены знаком CE.

Egoluce s.r.l. si riserva la facoltà di modificare, in qualsiasi momento e senza preavviso, le caratteristiche tecniche dei modelli illustrati nel presente catalogo.

I colori si intendono indicativi.

Egoluce s.r.l. reserves the right to change, at any time and without prior warning, the technical specification of any product illustrated in this catalogue.

Colours are simply indicative of the real nuance.

Egoluce s.r.l. se réserve le droit de modifier, à n'importe quel moment et sans préavis, les caractéristiques techniques des éléments illustrés dans ce catalogue.

Les couleurs sont simplement a titre indicatif.

Egoluce s.r.l. behält sich vor, jederzeit und fristlos die in beiliegendem Katalog erläuterten technischen Daten zu ändern. Die Farben sind nicht genau wirklichkeitsgetreu.

Egoluce s.r.l. Nos reservamos el derecho de cambiar, en cualquier momento y sin previo aviso de las especificaciones de los productos mostrados en este catálogo. Los colores son aproximados.

Фабрика Egoluce s.r.l. сохраняет за собой право в любое время и без предварительного уведомления менять технические спецификации любого изделия в этом каталоге.

EDITION

April 2023 © All rights reserved

ART DIRECTION, LAYOUT, GRAPHICS

U.T. Egoluce

PHOTOS

U.T. Egoluce



MADE IN ITALY

EGOLUCE s.r.l. Via I. Newton, 12 - 20016 Pero - Milano - Italy - Tel. +39 02339586.1 - Italia fax +39 023535112
Int. fax +39 0233911087 E-mail: info@egoluce.com - Int. E-mail: infoworld@egoluce.com - www.egoluce.com